



# Split Air Conditioner

© GREE 66163055 V1.0

OWNER'S MANUAL  
GREE AIR CONDITIONERS

## MODELS:

GWHD(14)NK3BO

GWHD(18)NK3DO

GWHD(24)NK3DO

GWHD(24)NK3EO

GWHD(28)NK3BO

GREE ELECTRIC APPLIANCES, INC. OF ZHUHAI

Web Site: <http://www.gree.com>

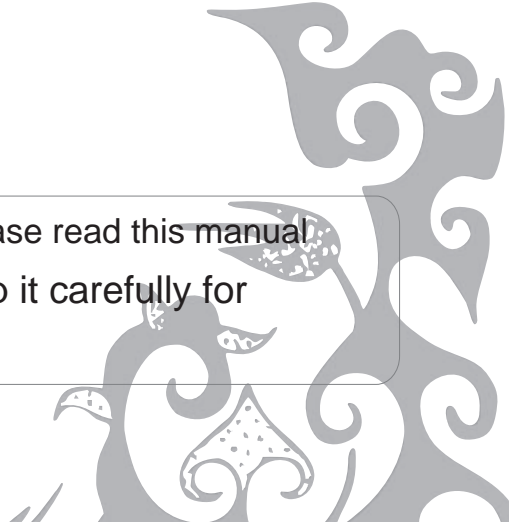

Thank you for choosing GREE air conditioners. Please read this manual attentively before starting up the unit and keep it carefully for future reference.

In line with the company's policy of continual product improvement, the aesthetic and dimensional characteristics, technical data and accessories of this appliance may be changed without notice.

## CONTENTS

## GENERAL INFORMATION

GENERAL INFORMATION	Conformity And Range	1
	The Instructions Befor Use	2
	Name Of The Parts	3
	Technical Data	4
	Outdoor Unit Working Temperature Range	4
INSTALLER	Electrical Connections	5
	Installing The Outdoor Unit	8
	Bleeding	8
	Maintenance	9
	Installation Dimension Diagram	9
	Check After Installation	10

The products in this manual may be different with the real one, according to different models, some models have displayer and some models without displayer, the position and shape of the displayer please refer to the real one.

## CONFORMITY AND RANGE

## GENERAL INFORMATION

The air conditioner you have purchased is in conformity with the following American Directives UL1995:

 Please read this owner's manual carefully before operating the unit and keep it carefully for consultation.

 Only use the air conditioner as instructed in this booklet. These instructions are not intended to cover every possible condition and situation. As with any electrical household appliance, common sense and caution are therefore always recommended for installation, operation and maintenance.

**WARNING**

★ When having a burning smell or smoke, please turn off the power supply and contact with the service center .

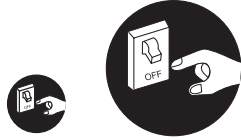

If the abnormality still exists, the unit may be damaged, and may cause electric shock or fire.

★ The power supply must adopt the special circuit that with air switch protection and assure it has enough capacity. The unit will be turned on or off according to your requirement automatically, please do not turn on or turn off the unit frequently, otherwise disadvantage effect may be caused to the unit.

★ Never cut off or damage power cables and control wires. If the power cable and signal control wire were damaged, change them by professional



★ Power must adopts the special circuit to prevent fire.

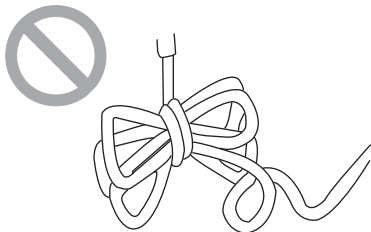

Otherwise, it can cause electric shock or fire.

★ Disconnect the power supply if long putting the air conditioner out of use.



Otherwise, the accumulated dusts may cause overheating or fire.

★ Never damage the electric wire or use the electric wire which is not appointed.



Otherwise, it will cause overheating or fire.

★ When cleaning, it is necessary to stop driving and turn off the power supply.

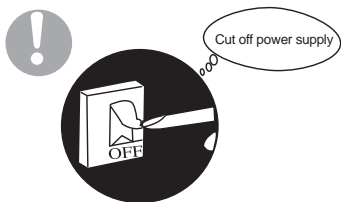

Otherwise, it may cause electric shock or damage.

★ Rated voltage of this airconditioner 220-240V,50Hz,The compressor will vibrate sharply if the voltage is too low, resulting in damage to refrigerating system. Electrical component are easy to damage if the voltage is too high.

★ Don't attempt to repair the air conditioner by yourself.

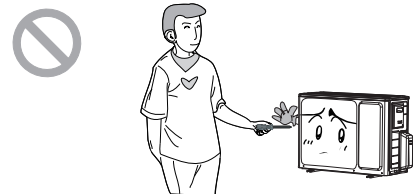

The wrong repair will lead to an electric shock or fire, so you should contact the service center to repair.

★ Please note whether the installed stand is firm enough or not.

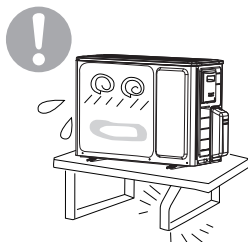

If it is damaged, it may lead to the fall of the unit and cause the injury.

★ Don't step on the top of the outdoor unit or place something on it.

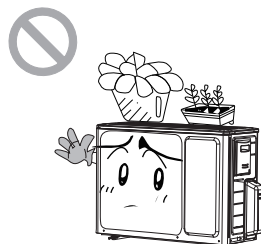

As falling off the outdoor unit can be dangerous.

★ Earthing: The unit must be reliably earthed. The earthing cable shall be connected to the special earthing device in the construction.



**GWHD(14)NK3BO, GWHD(18)NK3DO :**

**Warning**

- Be sure to cut off the power supply before cleaning the air conditioner; otherwise electric shock might happen.
- Wetting of air conditioner may cause the risk of electric shock. Make sure not to wash your air conditioner in any case.
- Volatile liquids such as thinner or gasoline will cause damage to the appearance of air conditioner. (Only use soft dry cloth moist cloth clean the air conditioner cabinet).
- This product must not be disposed together with the domestic waste. This product has to be disposed at an authorized place for recycling of electrical and electronic appliances.
- The temperature of refrigerant circuit will be high, please keep the interconnection cable away from the copper tube.



OUTDOOR UNIT	
No.	Description
1	Air outlet grille
2	Valve

Note: the above figures are only intended to be a simple diagram of the appliance and may not correspond to the appearance of the units that have been purchased.

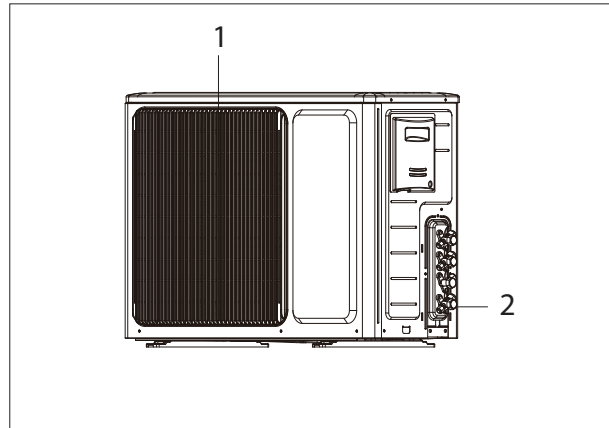

**GWHD(24)NK3DO, GWHD(24)NK3EO, GWHD(28)NK3BO :**

**Warning**

- If the supply cord is damaged, it must be replaced by the manufacturer or its service agent or a similarly qualified person in order to avoid a hazard.
- Be sure to cut off the power supply before cleaning the air conditioner; otherwise electric shock might happen.
- Wetting of air conditioner may cause the risk of electric shock. Make sure not to wash your air conditioner in any case.
- Volatile liquids such as thinner or gasoline will cause damage to the appearance of air conditioner. (Only use soft dry cloth moist cloth clean the air conditioner cabinet).
- Do not dispose this product as unsorted municipal waste. Collection of such waste separately for special treatment is necessary.
- The temperature of refrigerant circuit will be high, please keep the interconnection cable away from the copper tube.

OUTDOOR UNIT	
No.	Description
1	Air outlet grille
2	Valve

Note: the above figures are only intended to be a simple diagram of the appliance and may not correspond to the appearance of the units that have been purchased.

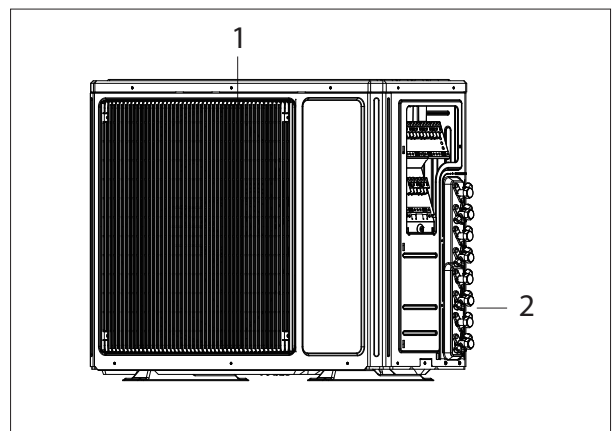

## TECHNICAL DATA

## GENERAL INFORMATION

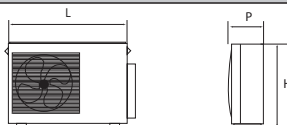
MODE	GWHD(14)NK3BO	GWHD(18)NK3DO	
Electrical data			
Electricity supply	220-240V~,50Hz		
Fuse or air switch	25	25	
Minimum power cord section	2.5	2.5	mm <sup>2</sup>
Refrigerant gas(R410A)	1400	1400	g
Size and clearance			
	L	818	mm
	P	378	mm
	H	596	mm

## TECHNICAL DATA

## GENERAL INFORMATION

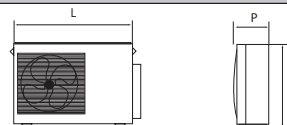
MODE	GWHD(24)NK3DO	GWHD(24)NK3EO	GWHD(28)NK3BO	
Electrical data				
Electricity supply	220-240V~,50Hz			
Fuse or air switch	40	40	40	
Minimum power cord section	4.0	4.0	4.0	mm <sup>2</sup>
Refrigerant gas(R410A)	2400	2200	2200	g
Size and clearance				
	L	890		mm
	P	362		mm
	H	700		mm

## OUTDOOR UNIT WORKING TEMPERATURE RANGE

## GENERAL INFORMATION

	Outdoor side DB/WB( °C )
Maximum cooling	43/26(T1)
Minimum cooling	21/-
Maximum heating	24/18
Minimum heating	-5/-6

**GWHD(14)NK3BO, GWHD(18)NK3DO, GWHD(24)NK3DO:**

1. Remove the handle at the right side plate of the outdoor unit (one screw).
2. Remove the cable clamp, connect the power connection cable with the terminal at the row of connection and fix the connection. The fitting line distributing must be consistent with the indoor unit. terminal of line bank. Wiring should meet that of indoor unit.
3. Fix power connection wire by wire clamp.
4. Ensure wire has been fixed well.
5. Install the handle.



- An all-pole disconnection switch having a contact separation of at least 3mm in all pole should be connected in fixed wiring.
- Wrong wire connection may cause malfunction of some electric components. After fixing cable, ensure that leads between connection to fixed point have some space.
- The connection pipes and the connecting wirings of the unit A and unit B must be corresponding to each other respective.
- The appliance shall be installed in accordance with national wiring regulations.

Note: the above figures are only intended to be a simple diagram of the appliance and may not correspond to the appearance of the units that have been purchased.

**GWHD(14)NK3BO, GWHD(18)NK3DO:**

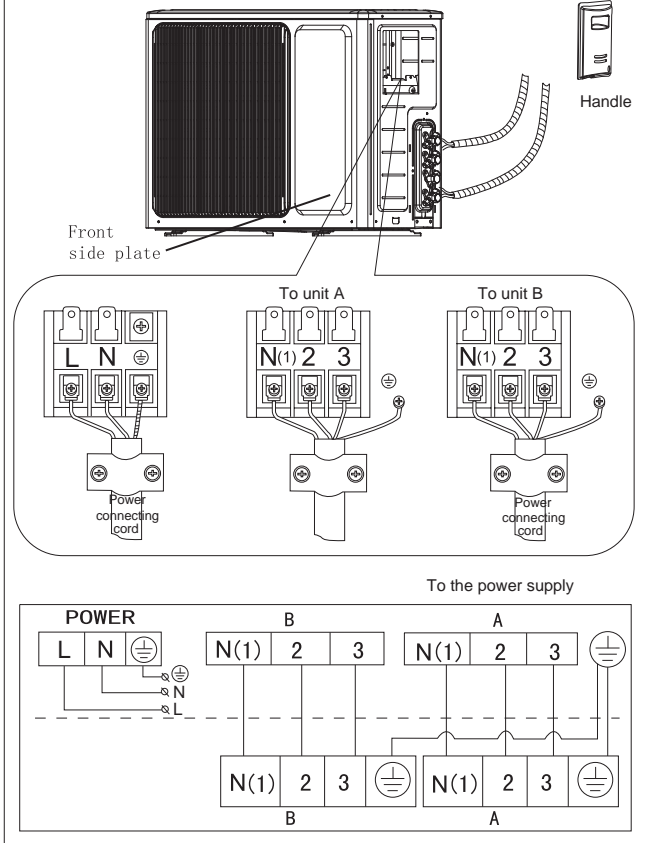

**GWHD(24)NK3DO:**

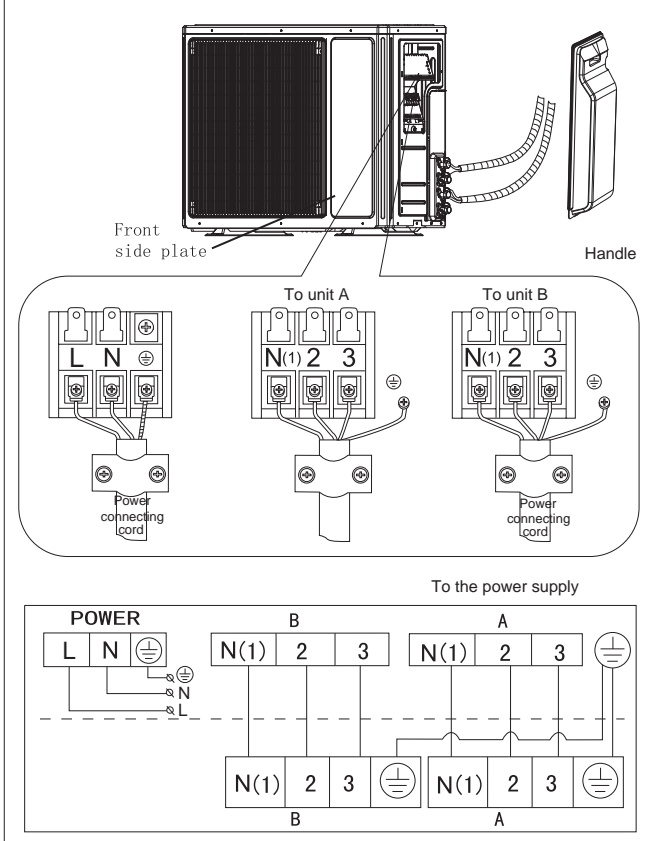

**GWHD(24)NK3EO :**

1. Remove the handle at the right side plate of the outdoor unit (one screw).
2. Remove the cable clamp, connect the power connection cable with the terminal at the row of connection and fix the connection. The fitting line distributing must be consistent with the indoor unit. terminal of line bank. Wiring should meet that of indoor unit.
3. Fix power connection wire by wire clamp.
4. Ensure wire has been fixed well.
5. Install the handle.



- An all-pole disconnection switch having a contact separation of at least 3mm in all pole should be connected in fixed wiring.
- Wrong wire connection may cause malfunction of some electric components. After fixing cable, ensure that leads between connection to fixed point have some space.
- The connection pipes and the connecting wirings of the unit A ,unit B and unit C must be corresponding to each other respective.
- The appliance shall be installed in accordance with national wiring regulations.
- Do not install the outdoor unit where it is exposed to the sunlight.

Note: the above figures are only intended to be a simple diagram of the appliance and may not correspond to the appearance of the units that have been purchased.

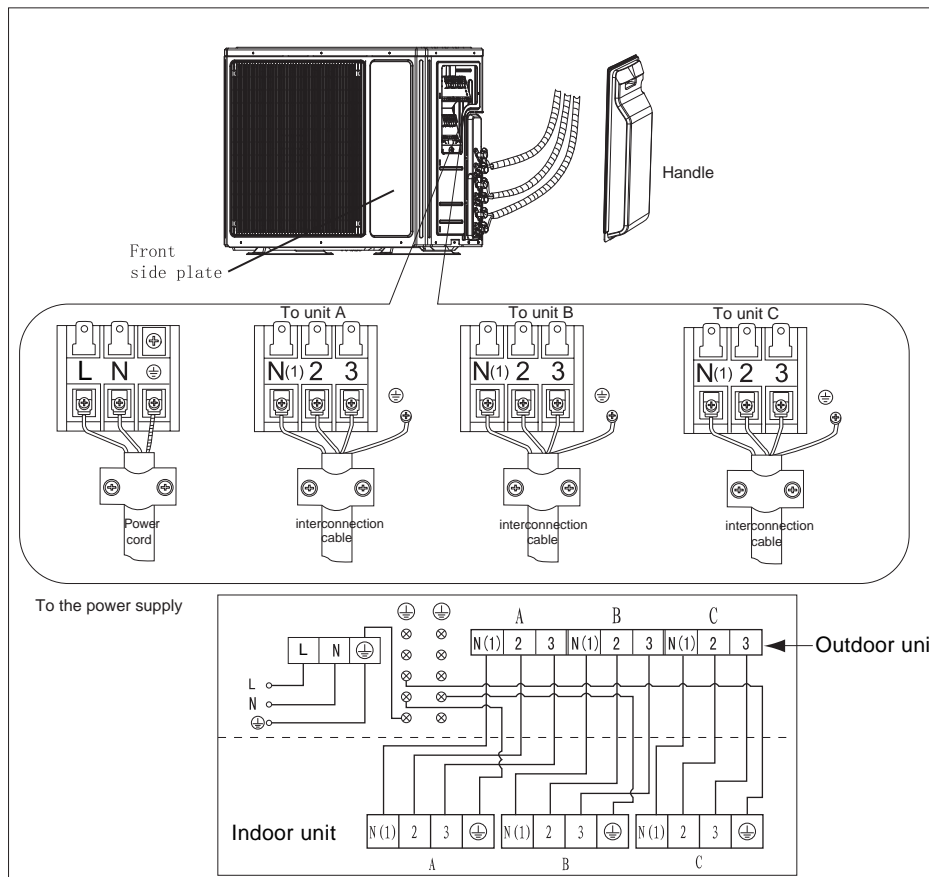

**GWHD(28)NK3BO :**

1. Remove the handle at the right side plate of the outdoor unit (one screw).
2. Remove the cable clamp, connect the power connection cable with the terminal at the row of connection and fix the connection. The fitting line distributing must be consistent with the indoor unit. terminal of line bank. Wiring should meet that of indoor unit.
3. Fix power connection wire by wire clamp.
4. Ensure wire has been fixed well.
5. Install the handle.



- An all-pole disconnection switch having a contact separation of at least 3mm in all pole should be connected in fixed wiring.
- Wrong wire connection may cause malfunction of some electric components. After fixing cable, ensure that leads between connection to fixed point have some space.
- The connection pipes and the connecting wirings of the unit A ,unit B,unit C and unit D must be corresponding to each other respective.
- The appliance shall be installed in accordance with national wiring regulations.
- Do not install the outdoor unit where it is exposed to the sunlight.

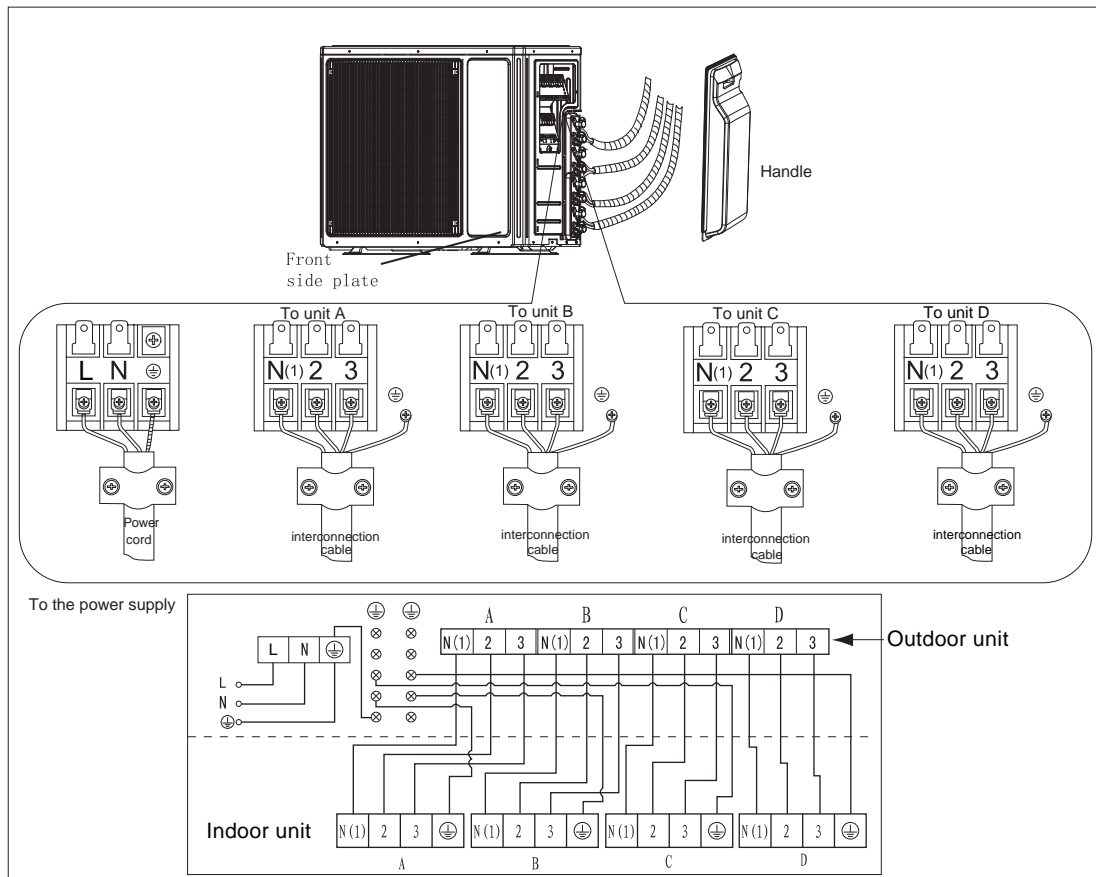

**HANDLING**

**USER**

- After having removed the packaging, check that the contents are intact and complete.
- The outdoor unit must always be kept upright.
- Handling must be done by suitably equipped qualified technical personnel using equipment that is suitable for the weight of the appliance.



### Location

**!** Use bolts to secure the unit to a flat, solid floor. When mounting the unit on a wall or the roof, make sure the support is firmly secured so that it cannot move in the event of intense vibrations or a strong wind.

**●** Do not install the outdoor unit in pits or air vents

### Installing the pipes

**!** Use suitable connecting pipes and equipment for the refrigerant R410A.

**!** The refrigerant pipes must not exceed the maximum lengths 10m.

**!** Wrap all the refrigerant pipes and joints.

**!** Tighten the connections using two wrenches working in opposite directions.

**Caution: Installation Must be Performed in Accordance with the NEC/CEC by Authorized Personnel Only.**

### Install the drain fitting and the drain hose (for model with heat pump only)

Condensation is produced and flows from the outdoor unit when the appliance is operating in the heating mode. In order not to disturb neighbours and to respect the environment, install a drain fitting and a drain hose to channel the condensate water. Install the drain fitting and rubber washer on the outdoor unit chassis and connect a drain hose to it as shown in the figure.

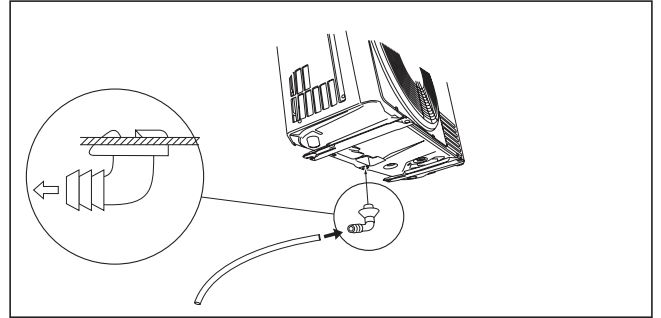

# BLEEDING

# INSTALLER

Humid air left inside the refrigerant circuit can cause compressor malfunction. After having connected the indoor and outdoor units, bleed the air and humidity from the refrigerant circuit using a vacuum pump.

- (1) Unscrew and remove the caps from the 2-way and 3-way valves.
- (2) Unscrew and remove the cap from the service valve.
- (3) Connect the vacuum pump hose to the service valve.
- (4) Operate the vacuum pump for 10-15 minutes until an absolute vacuum of 10 mm Hg has been reached.
- (5) With the vacuum pump still in operation, close the low-pressure knob on the vacuum pump coupling. Stop the vacuum pump.
- (6) Open the 2-way valve by 1/4 turn and then close it after 10 seconds. Check all the joints for leaks using liquid soap or an electronic leak device.
- (7) Turn the body of the 2-way and 3-way valves. Disconnect the vacuum pump hose.
- (8) Replace and tighten all the caps on the valves.

Diameter (mm)	Twisting moment (N.m)
∅ 6	15-20
∅ 9.52	35-40
∅ 16	60-65
∅ 12	45-50
∅ 19	70-75

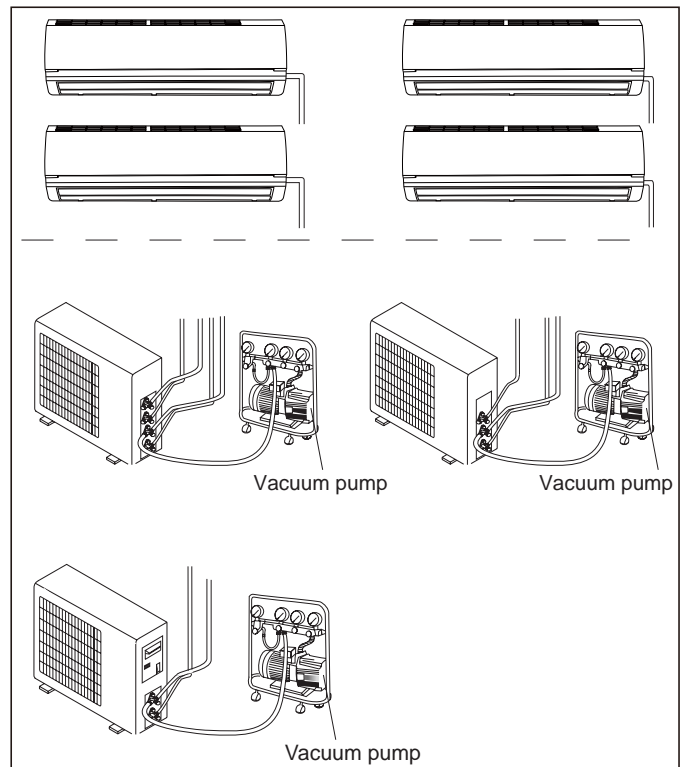

18K unit need to be installed the indoor unit

18K MODE:

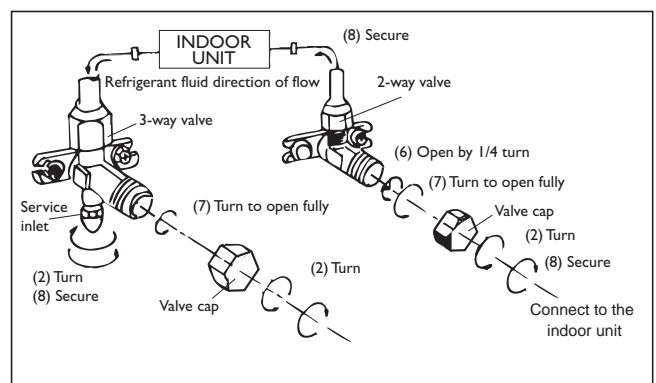
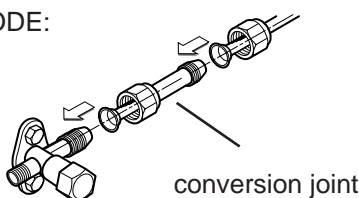

- ⚠ Use suitable instruments for the refrigerant R410A.
- Do not use any other refrigerant than R410A.
- ⚠ Do not use mineral oils to clean the unit.

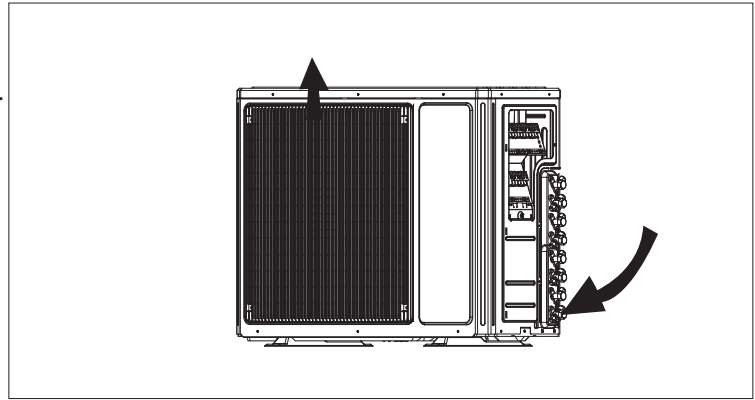

**INSTALLATION DIMENSION DIAGRAM**

- ⚠ The installation must be done by trained and qualified service personnel with reliability according to this manual.
- ⚠ Contact service center before installation to avoid the malfunction due to unprofessional installation.
- ⚠ When picking up and moving the units, you must be guided by trained and qualified person.
- ⚠ Ensure that the recommended space is left around the appliance.

GWHD(14)NK3BO, GWHD(18)NK3DO

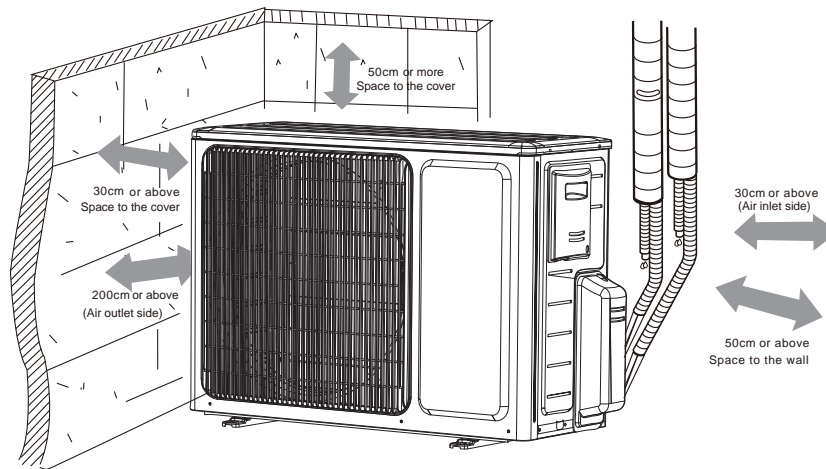

GWHD(24)NK3DO, GWHD(24)NK3EO, GWHD(28)NK3BO

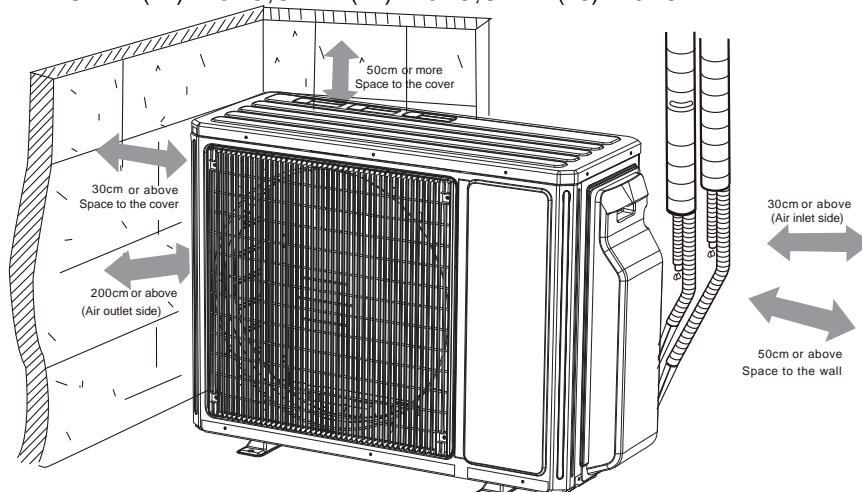

This is just the schematic plan, please refer to the actual product.

Check Items	Problems Owing to Improper Installation
Is the installation reliable?	The unit may drop, vibrate or make noises
Has the gas leakage been checked?	May cause unsatisfactory cooling (heating) effect
Is the thermal insulation of the unit sufficient?	May cause condensation and water dropping
Is the drainage smooth?	May cause condensation and water dropping
Does the power supply voltage accord with the rated voltage specified on the nameplate?	The unit may bread down or the components may be burned out
Are the lines and pipelines correctly installed?	The unit may bread down or the components may be burned out
Has the unit been safely grounded?	Risk of electrical leakage
Are the models of lines in conformity with requirements?	The unit may bread down or the components may be burned out
Are there any obstacles near the air inlet and outlet of the indoor and outdoor units?	The unit may bread down or the components may be burned out
Have the length of refrigerating pipe and refrigerant charge amount been recorded?	It is not easy to decide the charge amount of refrigerant.